



*Trusted for the Long Run*

REFERENCE  
GUIDE FOR

# Rings & Steel Travelers





*Trusted for the Long Run*

# AB Carter, Inc. Quality Statement

---

AB Carter, Inc. is dedicated to meet and exceed our customers' expectations and to form a partnership for continued long-term growth. We are committed to excellence in our products and service to our customers through continuous improvement, adherence to market driven standards, innovation, and the total involvement of all employees.

## How to Use this Guide

---

Simply click the topic from the Table of Contents to be taken to that page. Use the navigation along the top of each page to return to the Table of Contents or progress to the previous page or the next page.





# TABLE OF CONTENTS

Click the page you would like to visit.



- History**..... 4-5
- Traveler Function**..... 6-8
- Traveler Selection**..... 9
  - Traveler identification label..... 10
  - Traveler wire profiles with illustrations..... 11
  - Traveler finishes..... 12
  - Traveler style ..... 13
  - Yarn clearance considerations..... 14
  - General recommendations for Carter travelers..... 15
  - Traveler number (weight)..... 16
  - Traveler weight comparison chart..... 17
  - Traveler selection for specialty yarns..... 18-19
- Settings for Optimum Traveler Performance**..... 20
  - Traveler cleaner setting..... 21
  - Thread guide setting..... 22
  - Spinning ring to bobbin relationship..... 23
  - Balloon control ring setting..... 24
  - Angle of yarn pull..... 24
  - Traveler speeds and calculations..... 25
- Wear and Life of Travelers**..... 26-27
- Ring Spinning Problems and Solutions**..... 28
  - Trouble Shooting Chart..... 29-31
- Flange Spinning Rings**..... 32
  - Royal Rings..... 33
  - Spartan Rings..... 33
  - Description and Configuration of Rings for all Types of Spinning Frames..... 34-36
  - Break-In Instructions for Rings..... 37
  - Break-In Instructions for Royal Rings..... 38
  - Break-In Instructions for Spartan Rings..... 39
- Long Staple Spinning and Twisting**..... 40-42
- Technical Spinning Information and Formulas**..... 43-45
  - English Cotton Yarn Numbering System..... 46
  - Yarn Count Comparison Chart..... 47
  - Standardized Fiber Abbreviations..... 48
- Accessories and other Parts**..... 49
  - Traveler Hooks..... 50
  - Fluff Removers..... 51
  - Carter Speed Tool..... 52
  - Agent Locations..... 53



## History

---

**AB Carter, Inc.** is universally recognized as a quality supplier of spinning accessories and other products utilized throughout the yarn manufacturing sector of the textile industry. In addition, AB Carter, Inc. also serves other industries through the sale of low carbon wire and yarn/composite splicing products.

AB Carter, Inc. began manufacturing and marketing its first product the Boyce Weavers Knotter shortly after the Company was founded by Arthur Bynum Carter in 1922. Mr. Carter's interest and expertise in the application of rings and travelers for producing quality spun yarns led the way for establishing the metal traveler business in 1937.

The Company has continued to grow over the years through acquisitions of companies and product lines but most importantly through servicing our customers' needs.

### **The AB Carter, Inc. brand promise:**

- Since 1922 - hundreds of new products and innovations
- Global company - with offices in 5 countries and agents in 42 countries
- ISO 9001 quality management system - a way of life since 1996
- Vertically integrated manufacturing processes - from raw materials to finished products
- Comprehensive products and services - supporting all types of fiber and yarn processing
- Field support technical staff - averaging 25 years of textile experience





AB Carter, Inc. now markets a diverse line of products through several divisions with specialized industry knowledge. The yarn division maintains the necessary technical expertise in order to assist customers with application, operation and servicing issues. Comprehensive yarn support includes products, parts and accessories for cotton spinning, man-made fiber, sewing thread, chenille yarn, tire cord and carpet yarn plants.

AB Carter, Inc., and its growing list of equity partners, supply quality specialty products to yarn producers worldwide with the following brand commitment.

- World's most comprehensive selection - manufacturer and supplier of traveler styles and weights for every possible application.
- International supplier and solution provider - to world's leading yarn and fiberglass manufacturers.
- Patent holder and manufacturer - of industry specific ring and traveler finishes for longer life, quality and wear.
- Specialists and committed implementer - of continuous improvement for new and innovative products for yarn producers.
- Value-added innovative partner - offering research, development, technology, skills and resources developed from careful growth and appropriate acquisitions.



Contact AB Carter, Inc. to discuss your next yarn production requirement.





FUNCTION:

# Flange Travelers

Understanding the functions of the traveler will aid in the recommendation of the proper traveler for each situation.





### **The Traveler Controls the Build of the Bobbin**

The path of the traveler is controlled by the ring on which it is mounted and by the movement of the rail on which the ring is mounted. The rail moves up and down in a prescribed motion in order to make a proper build of the yarn package. The ring is stationary on the rail. The traveler sits loosely on the ring. The yarn from the delivery rollers passes through the traveler and then on to the bobbin and yarn package surface. As the bobbin rotates, the traveler is pulled by the yarn that is being taken up onto the surface of the rotating bobbin. Therefore the traveler guides the yarn onto the bobbin as the rail moves the ring up and down and the traveler is controlled by the ring's position in relation to the bobbin.

### **The Traveler Controls Yarn Tension**

The ring guides the traveler in a circular path around the bobbin. Therefore the traveler is constantly changing direction or else it would fly off in a straight path tangential to the ring. This creates a force called centrifugal force. The constant changing of direction of the traveler by the ring causes friction between the ring and the traveler. The friction between the ring and the traveler operating in a circular path acts as a brake working against the traveler. This friction creates tension on the yarn. The tension applied to the yarn is controlled by the weight of the traveler, the speed of rotation of the bobbin, the weight of the yarn in the balloon and the friction on the yarn as the yarn balloon passes through the air. Proper tension allows the spinning operation to proceed efficiently while maintaining optimum yarn quality. Proper tension on the yarn is critical to forming a yarn package that will allow the yarn to be unwound from the bobbin at the next operation.

### **The Traveler Is a Speed Differential**

The yarn being delivered has a much slower surface speed than does the surface of the rotating bobbin. If the traveler speed were equal to the speed of the yarn, the yarn would be broken between traveler and the bobbin by the higher take up speed of the rotating bobbin surface. Conversely if the traveler speed were equal to the surface speed of the rotating bobbin, the yarn would be broken between the delivery rollers and the traveler. Therefore the speed of the traveler must accommodate the two different speeds of the rotating bobbin and the yarn being delivered by the delivery rollers. It does this by being free to adjust its speed simultaneously to the surface speed of the bobbin and the delivery speed of the yarn. The traveler speed is continuously changing because the yarn package is building on a taper in order for the yarn to be unwound at the next operation. This speed fluctuation can be observed when looking at the traveler in operation with the help of a stroboscope.



### **The Traveler Allows Twist to Be Inserted into the Yarn**

The traveler acting as a differential also twists the yarn. The twisting of the yarn is important in order to bind the bundle of fibers together under tension to allow each fiber to contribute its strength to the resultant yarn. To calculate the yarn twist, the RPM of the spindle times Pi times the ring diameter divided by the inches of yarn being delivered by the delivery rollers in one minute will give the turns of twist in one inch of yarn.

The bundle of fibers is being twisted into yarn because the traveler rotating around the center of the spindle lags behind the rotational speed of the spindle. The same action is taking place on a ring twister where the individual yarns or the individual filaments are being twisted together by this speed differential of the yarn delivery speed and the RPM of the spindle.

### **The Traveler Is Important to Yarn Quality**

Every inch of yarn being formed in ring spinning must pass through a traveler. Proper traveler selection is critical to maintain the quality of the fibers individually and also the yarn. If the traveler tension is too great, there can be a loss of yarn strength, high end breaks during spinning, problems when dyeing the yarn due to fiber damage and greater wear to both the ring and the traveler. When the traveler is too light, yarn hairiness increases especially at the bottom of the bobbin, end breaks are greater especially at the bottom of the bobbin and greater “fly” is created by higher pressure of the yarn against the balloon control rings and even by the yarn contacting the separator blades.

The shape of the traveler is important to allow adequate clearance for the yarn to pass through the traveler without being in harsh contact with the top of the ring. Neps can be formed if harsh contact with the top of the ring occurs. The traveler width, height, cross sectional profile, shape where the yarn runs and the shape forming the contact point between the ring and the traveler are important when selecting the traveler. The overall shape of the traveler should be selected according to the fiber properties, speed, yarn count, spinning geometry and spinning performance.





SELECTION:

# Flange Travelers

There is not an exact formula for choosing the proper traveler for ring spinning or twisting applications due to the many variables associated with the processes and end product. We have developed the following information, charts and illustrations to help the customer understand the basics involved in the traveler selection process. Please remember that this information is simply a general overview and traveler selection is normally done by experimentation through a process of trial and elimination.

For this reason, we always recommend that the customer use AB Carter, Inc. technical staff for assistance in choosing the correct ring and traveler combination in order to achieve optimum yarn quality and processing performance in all traditional and compact spinning applications.



Travelers are available in different styles and numbers (weights) with varying wire profiles and finishes to accommodate virtually any spinning and twisting requirement.

**The photo illustration below shows an example of our traveler identification label which describes our numbering system terminology.**

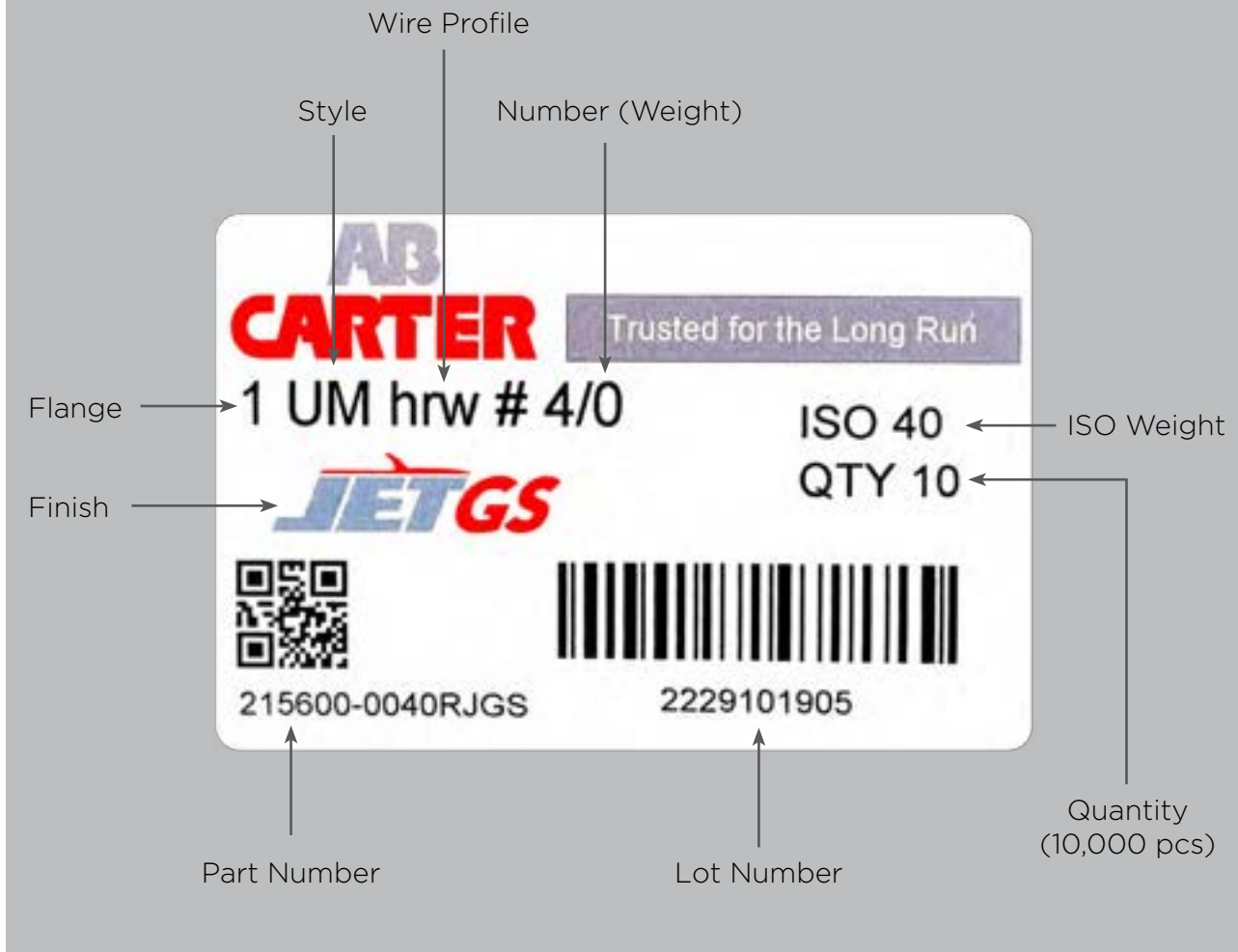







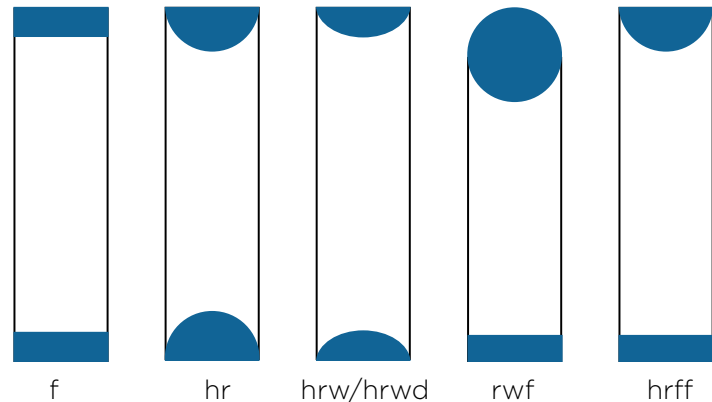

### Traveler Wire Profile

The traveler wire profile is the cross section of wire used to manufacture the travelers. Using the proper wire profile is very important in terms of optimizing yarn quality and spinning productivity. The common wire profiles for the production of flange travelers are shown in the illustration below.

- f = flat
- hr = half round
- hrw = half round wide
- hrwd = half round wide modified
- rwf = round wire flat
- hrff = half round flat foot



### Wire Shape Application

 f	The FLAT wire profile is used on 100% cotton. It is used for special applications to reduce yarn hairiness. Ask for availability by travelers number and profile.
 hr	The "hr" profile protects fibers from damage for synthetics and blends and reduces nep formation on fine cotton yarns.
 hrw/hrwd	The "hrw/hrwd" profile is used for cotton and blends and allows maximum production rates.
 rwf	For Core Yarns and sensitive synthetics fibers. Combination of round profile and flat foot profile gives smooth yarn contact plus maximum yarn clearance. Usually for Aramid fibers.
 hr ff	For Core Yarns with elastic yarn as the core. Also used on synthetic yarns.





### Traveler Finishes

Special finishing treatments have been developed for flange travelers to maximize spinning speeds, improve traveler life, reduce running-in time, prevent corrosion, resist yarn abrasion and reduce heat build-up on the ring.



#### Diffusion Treatment

Application: Specially designed premium finish for high performance applications on Royal Ring and other chrome rings. Enhances traveler life while minimizing yarn hairiness.



#### Electrolytic Surface Treatment

Application: Universal (Bright Nickel) finish for use on all fiber types and yarn counts. Optimum resistance to corrosion.



#### Chemically Deposited Nickel Alloy

Application: Nickel coating for use on fine count synthetic yarns and dyed yarns.



#### Lubricating, Extended Life Traveler

Our LONG LIFE finish, developed for all fiber types and all levels of speed. Increases the traveler and ring life.







## Traveler Style

The traveler style indicates the general shape of the traveler in regards to height and diameter. These dimensional characteristics are extremely important when matching the style for a particular application and fiber type. We have designed our travelers specifically to match the ring profile allowing the proper traveler balance and yarn clearance to optimize yarn quality and spinning performance. As a general rule of thumb, the traveler style should be no larger than necessary to fit the ring flange and provide adequate yarn clearance. Using a style larger than necessary can result in excessive ends down and ring damage.





## Yarn Clearance Considerations

It is important to consider the shape of travelers for maintaining optimum yarn quality. Yarn count, fiber type, twist and traveler speed are important factors to be considered.

### High Profile

---

Travelers with a high profile give excellent clearance for coarse yarns. Yarn with heat sensitive fibers are more protected from the point of contact between the ring and traveler. Slub yarns pass more freely thus protecting the slub quality and reducing end breaks. There is less lubrication by the fiber.



### Medium Profile

---

Travelers with medium profile give adequate clearance for medium to fine yarn counts. The ring and traveler contact point receives adequate lubrication from the fiber.



### Low Profile

---

The low profile is best for fine count yarns, and compact yarns due to the limited yarn clearance. The low profile allows for high productivity for very fine counts and compact yarns. The low profile gathers more lubrication from high twist and compact yarn.





**Travelers for Flange 1 and ½ Flange Rings**

<b>Profile</b>	<b>Range</b>	<b>Application</b>
1/2 FGUL hrw	15/0 - 28/0	Fine Counts: Compact Cotton in flange 1/2 rings
1/2 CPC hrw	12/0 - 26/0	Fine Counts: Compact Cotton in flange 1/2 rings
1/2 CPFL hrw	12/0 - 26/0	Fine Counts: Compact Cotton in flange 1/2 rings
1 FGUL hrw	15/0 - 28/0	Fine Counts: Compact Cotton
1 FGL hrw	10/0 - 24/0	Fine Counts: Cotton, Normal and Compact
1 FGM hrw	3/0 - 15/0	Medium to Fine Counts : Cotton, Normal and Compact
1 FGH hrw	1/0 - 18/0	Medium Counts: Cotton, Normal and Compact
1 CPC hrw	12/0 - 26/0	Fine Counts: Compact Cotton
1 CPFL hrw	12/0 - 26/0	Fine Counts: Compact Cotton
1 CPF hrw	4/0 - 18/0	Medium to Fine Counts: Normal and Compact
1 CPFM hrw	4 - 12/0	Medium to Fine Counts: Normal and Compact
1 CFH hrw	8/0-22/0	Fine to Super Fine Counts: Compact Cotton
1 CCH hrwd	1-10	Medium to Course count: Normal and Compact
1 ELB hrw	1/0 - 10/0	Medium to Fine Counts: Normal and Compact
1 EL hrw	1/0 - 10/1	Medium to Fine Counts: Normal and Compact
1 SPM hrw	2 - 7/0	Medium to Fine Counts: Blends and Synthetics
1 EM hrw	10 - 7/0	Coarse to Medium Counts: Synthetics
1 UL hr/hrw	1/0 - 20/0	Medium to Fine Counts : Cotton and Blends
1 UWL hrw	10 - 12/0	Medium to Fine Counts : Cotton and Blends
1 UWLG hrw	3 - 12/0	Medium to Fine Counts : Cotton
1 UWLT hrw/hrwd	3 - 12/0	Medium to Fine Counts : Blends and Synthetics
1 UM hrw	10 - 12/0	Medium to Fine Counts : Cotton, Blends and Synthetics
1 UM hrwd	10 - 12/0	Medium to Fine Counts : Cotton, Blends and Synthetics
1 RMT hrw	6 - 7/0	Medium Counts : Cotton, Blends and Synthetics
1 RMT hr	8 - 10/0	Medium Counts: Synthetics and Blends
1 SM1 hr, f	6 - 7/0	Medium Counts : Cotton, Blends and Synthetics
1 UTM hr, hrw	2 - 10/0	Medium to Fine Counts: Cotton, Blends and Synthetics
1 UTH hr, hrw	11 - 1	Medium Counts: Cotton, Blends and Synthetics
1 UT1 hr	12 - 3	Course to Medium Counts: Cotton, Blends and Synthetics
1 CB hr, f	6 - 7/0	Medium Counts: Cotton and Blends
1 BKH rwf	8 - 4/0	Medium Counts: Aramid Fibers
1 RMH f, hrw	9 - 7/0	Medium to fine Counts: Cotton and Blends
1 USTL hrw	6/0 - 16/0	Fine Counts: Cotton, Blends and Synthetics
1 USTM hrw	1/0 - 10/0	Medium Counts: Cotton, Blends and Synthetics
1 USTH hrw	12 - 1	Coarse to Medium Counts: Cotton, Blends and Synthetics



## Travelers for Flange 2 Rings

Profile	Range	Application
2 SM2 hr	12 - 6/0	Coarse to Medium Counts: Cotton, Blends, Core, Slub and Denim
2 UT1.5 hr, hrff	28 - 3/0	Coarse to Medium Counts: Cotton, Blends, Core, Slub and Denim
2 EM hrw	14 - 1	Coarse to Medium Counts: Cotton, Blends, Core, Slub and Denim
2 SH2 hrw	12 - 6/0	Coarse to Medium Counts: Cotton, Blends, Core, Slub and Denim
2 KFT1.5 hr	12 - 3/0	Coarse to Medium Counts: Cotton, Blends, Core, Slub and Denim
2 EH hrw	14 - 1	Coarse to Medium Counts: Cotton, Blends, Core, Slub and Denim
2 MTW2 hrw	44 - 5	Coarse to Medium Counts: Cotton, Blends, Core, Slub and Denim

## Travelers for Legacy Rings

Profile	ISO Range	Application
OF hrw	11 - 140	Cotton, Blends and synthetics course/medium yarns Compact
OF hr	11 - 140	Cotton, Blends and synthetics course/medium yarns Conventional
OR hrw	11 - 140	Cotton and blends medium/fine Compact
OR hr	11 - 140	Cotton and blends medium/fine Compact

## Traveler Number (Weight)

Selecting the proper traveler number (weight) is a critical part of optimizing spinning performance and yarn quality. The ideal number (weight) will properly control the yarn balloon thus producing a firm package. Greater traveler friction against the ring from heavy travelers generates heat that may damage fibers, burn travelers and cause excessive ring wear. The correct traveler weight is determined after practical trials on a specific application.

### The following factors will influence the proper choice of traveler number (weight):

- Friction between the traveler and ring
- Ring condition
- Lubrication
- Spindle speed
- Air conditioning and relative humidity
- Yarn twist

The choice of traveler number (weight) is based on the number of yarn breaks during all phases of filling the bobbin. Breaks occur when the spinning tension is higher than the yarn strength. Yarn breaks most likely occur at the top and bottom of the bobbin during build-up.

The proper choice of traveler number (weight) will minimize variations in yarn breaks during all phases of filling the bobbin. Very light travelers in certain situations can cause yarn breaks due to an oversized balloon. Such a balloon can allow the yarn to have excessive pressure on the balloon control rings or touch the separators, causing yarn hairiness. Also, light travelers produce soft packages which cause downstream processing problems. Travelers which are too heavy for the application can cause yarn breaks in the upper part of the bobbin.





### Traveler Weight Comparison Chart

AB Carter		R & F		Bracker	Kanai
Traveler No.	ISO No.	ISO No.	ISO No.	ISO No.	ISO No.
28/0	6.3	5	6.3		
26/0	7.1	6	7.1		
24/0	8	7.1	8	10	
22/0	9	8	9	11	
20/0	10	9	10	12	
19/0	11.2	10	11.2	13	
18/0	12.5	11.2	12.5	14	
17/0	13.2	11.8	13.2	15	
16/0	14	13.2	14	15	
15/0	15	14	15	17	
14/0	16	15	16	18	
13/0	17	16	17	20	
12/0	18	18	18	21	
11/0	20	19	20	23	
10/0	22.4	20	22.4	25	
9/0	23.6	22.4	23.6	26	
8/0	25	23.6	25	28	
7/0	28	26.5	28	30	
6/0	31.5	30	31.5	32	
5/0	35.5	31.5	35.5	35	
4/0	40	35.5	40	38	
3/0	45	40	45	42	
2/0	50	45	50	49	
1/0	56	50	56	55	
1	63	60	63	62	
2	71	71	71	74	
3	80	80	80	81	
4	90	85	90	88	
5	95	95	95	95	
6	100	106	100	108	
7	112	112	112	112	
8	125	125	125	135	
9	140	140	140	156	
10	160	160	160	176	
11	180	180	180	204	
12	200	200	200	225	
13	224	224	224	245	
14	250	236	250	265	
15	265	250	265	286	
16	280	265	280	299	
17	300	280	300	313	
18	315	300	315	327	
19	335	315	335	340	
20	355	325	355	351	
22	375	355	375	378	
24	400	385	400	404	
26	425	415	425	431	
28	450	425	450	456	
30	475	475	475	483	



## Compact Yarns

It is helpful to consider the physical properties of the yarn type when selecting the proper travelers to be used. The rotation of the bobbin of yarn on the spindle and the resultant revolution of the traveler around the ring inserts twist into the fibers emerging from the front rolls. The twisting process forms these fibers into yarn. The twist continually migrates toward the emerging fibers but can only migrate to the “spinning triangle”. Compact spinning condenses the fibers to a narrow band as it exits the front rollers of the drafting system. Non-compact spinning does not control the fiber mass in this way. Therefore the spinning triangle is considerably wider on non-compact spinning than on compact spinning. The narrow spinning triangle of compact spinning allows a greater percentage of fibers to be spun into the body of yarn. The compact yarn therefore is smoother, gains strength from a higher percentage of fibers than non-compact, has greater luster and hairiness is reduced. The traveler friction is higher when spinning compact yarns because the fiber lubrication is less. For this reason, it is necessary to select travelers with minimal yarn clearance and stable running characteristics. The small yarn clearance positions the yarn in the traveler to allow the shorter and less numerous fibers that protrude from the body of the yarn to lubricate the traveler as it revolves around the ring.

The longer and more numerous fibers protruding from the body of non-compact yarn more easily contribute lubrication to the traveler. Therefore, the traveler selected must allow for more clearance of the yarn.

## Core Yarns

Core yarns are a multi-component yarn made up of a central core covered by staple fibers. The two types of core yarn are:

1. PES filament (Hard Core) – This polyester filament is used in applications where yarn strength is required, such as sewing thread. It is important to select a traveler shape that will provide sufficient yarn clearance between the traveler and top of the ring flange so the covering fibers will not be pushed back. Heavier traveler weights are used for this filament core yarn when compared to regular yarns. The rwf & hrff wire profiles are recommended for this filament core to minimize the traveler contact area against the yarn while giving the yarn a smooth radius of contact through the traveler.
2. Filament (Soft Core) – This type of core filament is used in applications for stretch knitted or woven fabrics. Again, it is important to select a traveler that will provide sufficient yarn clearance between the traveler and top of the ring flange so the covering fibers will not be pushed back. The hr and hrw wire profiles are recommended.



## Slub Yarns

Slub yarn is the result of a spinning machine being adjusted to produce sections of yarn that are larger than the rest of the yarn. When the yarn is knitted or woven into fabric, the result is that the slubs provide a desired pattern or effect in the fabric. Traveler weight selection for spinning slub yarns can sometimes be difficult. The traveler weight must be heavy enough to control the balloon when the slub is produced, yet light enough to not break the yarn at the weakest point, which is immediately after the slub.

The optimum traveler weight must be established through trials. The traveler circle size should be large enough to allow the slub to pass through without being pinched between the traveler and the top of the ring flange. The hr and hrw wire profiles are recommended for slub yarns.



# Settings for optimum traveler performance.

After selecting the correct traveler, the following settings should be strictly maintained to assure optimum performance.







## Traveler Cleaner Setting

The purpose of the traveler cleaner is to remove fiber fly that can accumulate on the travelers. The traveler cleaner should be set to the proper distance from the outside of the ring flange. Incorrect traveler cleaner settings can result in traveler wear, increased yarn tension, end breaks and ring damage.

### Causes of traveler loading:

- **Yarn Count Processed**

Heavier travelers are used for heavier counts and tend to catch more fiber fly than lighter travelers.

- **Profile of Traveler**

Flat and hrw/hrwd travelers tends to accumulate more fiber fly than hr travelers.

- **Fiber Staple Length**

Shorter fibers yield more fiber fly than longer fibers, especially in processing carded cotton yarn.

- **Twist of Yarn**

Low twist yarns such as those for knitting yield more fiber fly than that for weaving.

- **Rate of Air Exchange**

Poor rate of air exchange in the spinning room increases the chance of stray fibers in the air to be caught by the travelers.

- **Relative Humidity**

Lower RH in the spinning room allows the stray fibers to flow in the air for longer periods, thus creating higher chance of loading on travelers.



Clearance between outer flange of ring and traveler cleaner is calculated as follows:

- Clearance = Traveler inner diameter - flange width of ring + thickness of traveler + (0.3-0.5) mm
- Recommended actual clearance between outer face of traveler and traveler clearer:  
0.3mm - for synthetic fibers and combed cotton  
0.5mm - for carded cotton and bulky materials

### **Thread Guide Setting**

Center the back center of the thread guide to the center of the spindle. The distance of the thread guide to the top of tube should be 1 ½ to 2 times the diameter of the tip of the spinning tube. The ring rail should be at the lowest position when making this setting.



### Spinning Ring to Bobbin Relationship

The relationship between the spinning ring dimension and bobbin dimension is very important. We recommend a 5:1 ratio, meaning that the bobbin height is five times the ring ID.

$$H/D = 5 \text{ or } H = 5D$$

Example:  
ID = 45 mm  
H = 5 X 45 mm  
H = 225 mm

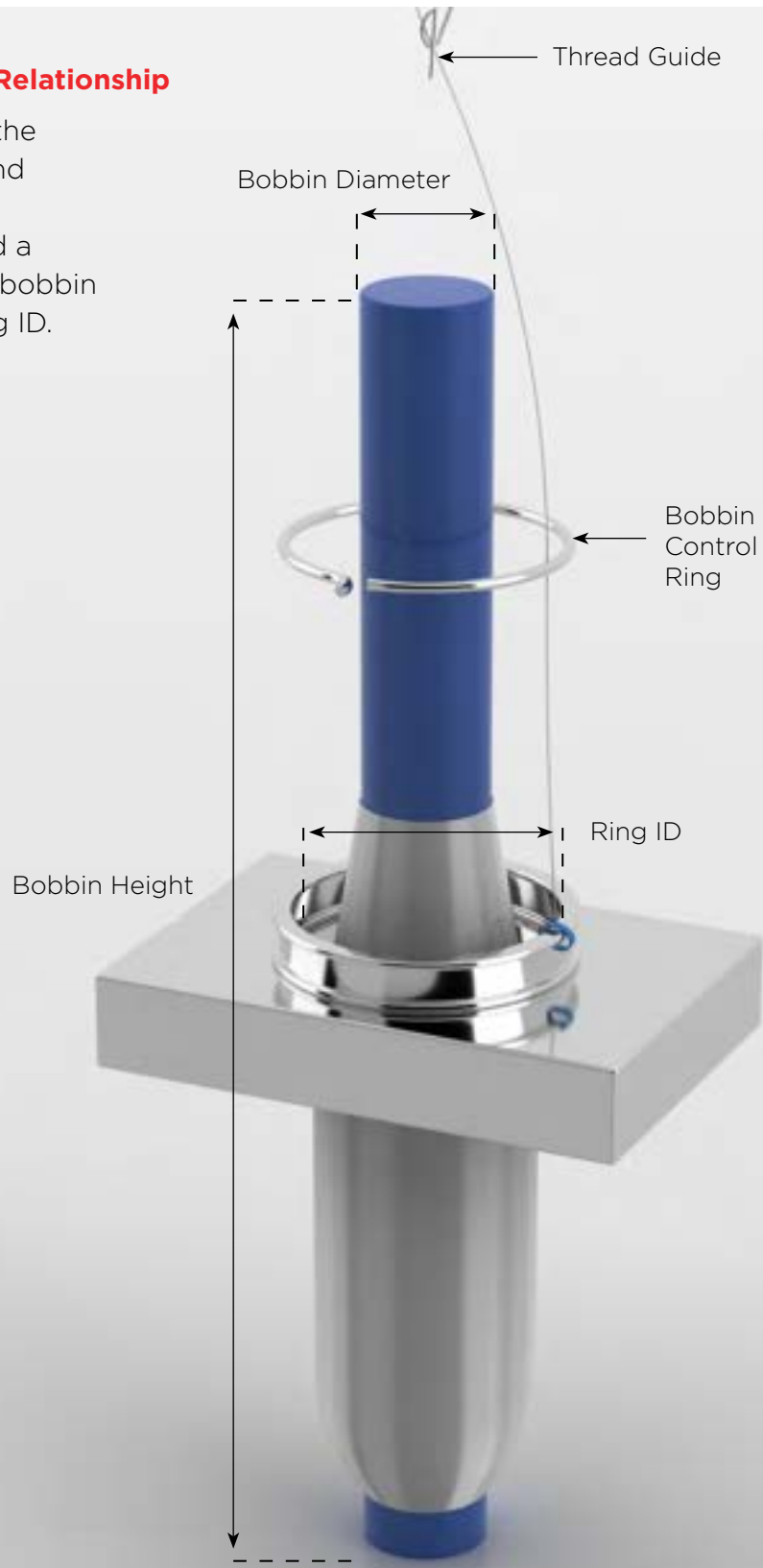



### Balloon Control Ring Setting

The balloon control ring should be centered to the spindle. The inside diameter should be 2mm greater than the inside diameter of the spinning ring. The balloon control ring should be set at 2/3 the distance between the ring rail and the thread guide. The ring rail should be at the lowest position when making this setting.

### Angle of Yarn Pull

In order to maintain high efficiency during spinning, the amount of tension experienced by the yarn should be set at a minimum level that still controls the balloon of the yarn. The angle of yarn pull becomes a critical value. The angle of pull is described by the angle produced by the yarn from the traveler to the surface of the bobbin and an imaginary line drawn from the traveler to the center of the spindle. (See illustration below). Using mechanics, one can determine that as the angle decreases, the yarn tension increases. The angle of pull can be calculated using the formula listed below.

We recommend an angle of yarn pull of 30° as ideal, with the angle never falling below 27°. In order to achieve this angle, the bobbin diameter should be half of the ring ID. While the yarn tension will decrease with angles over 30°, angles of pull greater than 31° tend to waste space, reducing efficiency. It is also important to note that increasing the ring ID without increasing the bobbin diameter will decrease the angle of yarn pull, thus the pull angle should be recalculated anytime a change to either the ring or bobbin size is proposed.

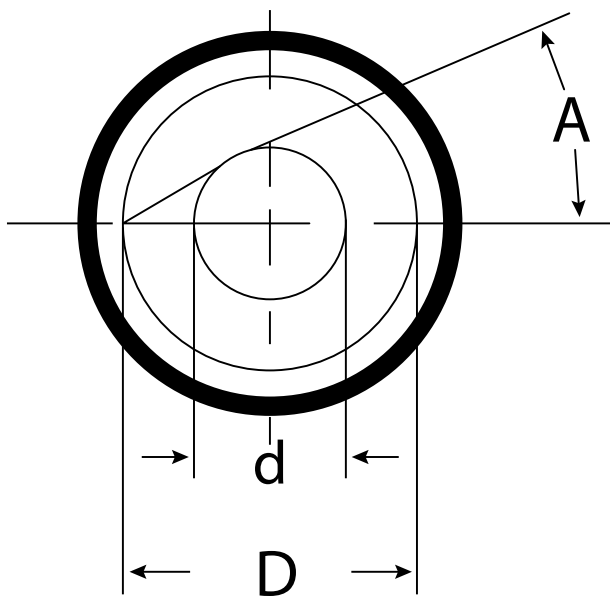

A = Angle of yarn pull  
 D = Ring ID  
 d = Minimum bobbin Diameter

$A = \sin^{-1} (d/D)$   
 Example:  $A = \sin^{-1} (d/2D) = \sin^{-1} (0.5) = 30^\circ$

**Note:** The bobbin diameter used in our calculations is the minimum bobbin diameter, not the average bobbin diameter. Thus, this would be the diameter at the top of a tapered bobbin.



### Traveler Speeds and Calculations

Speed (rpm)	Ring Diameter mm										
	34	35	36	38	40	42	45	48	50	54	60
7500									20	21	24
8000								20	21	23	25
8500							20	21	22	24	27
9000							21	23	24	25	28
9500							22	24	25	27	30
10000						22	24	25	26	28.3	31
10500						23	25	26	27	30	33
11000					23	24	26	28	29	31	35
11500					24	25	27	29	30	33	36
12000					25	26	28	30	31	34	
12500					26	27	29	31	33	35	
13000					27	29	31	33	34	37	
13500				27	28	30	32	34	35	38	
14000			26	28	29	31	33	35	37		
14500			27	29	30	32	34	36	38		
15000		27	28	30	31	33	35	38	39		
15500		28	29	31	32	34	37	39	41		
16000	28	29	30	32	34	35	38	40	42		
16500	29	30	31	33	35	36	39	41			
17000	30	31	32	34	36	37	40	43			
17500	31	32	33	35	37	38	41	44			
18000	32	33	34	36	38	40	42	45			
18500	33	34	35	37	39	41	44	46			
19000	34	35	36	38	40	42	45				
19500	35	36	37	39	41	43	46				
20000	36	37	38	40	42	44	47				
20500	36	38	39	41	43	45	48				
21000	37	38	40	42	44	46					
21500	38	39	41	43	45	47					
22000	39	40	41	44	46	48					
22500	40	41	42	45	47						
23000	41	42	43	46	48						
23500	42	43	44	47	49						
24000	43	44	45	48	50						
24500	44	45	46	49							
25000	45	46	47	50							
25500	45	47	48								
26000	46	48	49								
26500	47	49									
27000	48	49									
27500	49	50									
28000	50	51									

$$V \text{ (m/s)} = \frac{3.1415 \times \text{Ring Diameter} \times \text{rpm}}{60 \times 1000}$$

Exceeds recommended speed

  

Flange 1/2

Flange 1

Flange 2



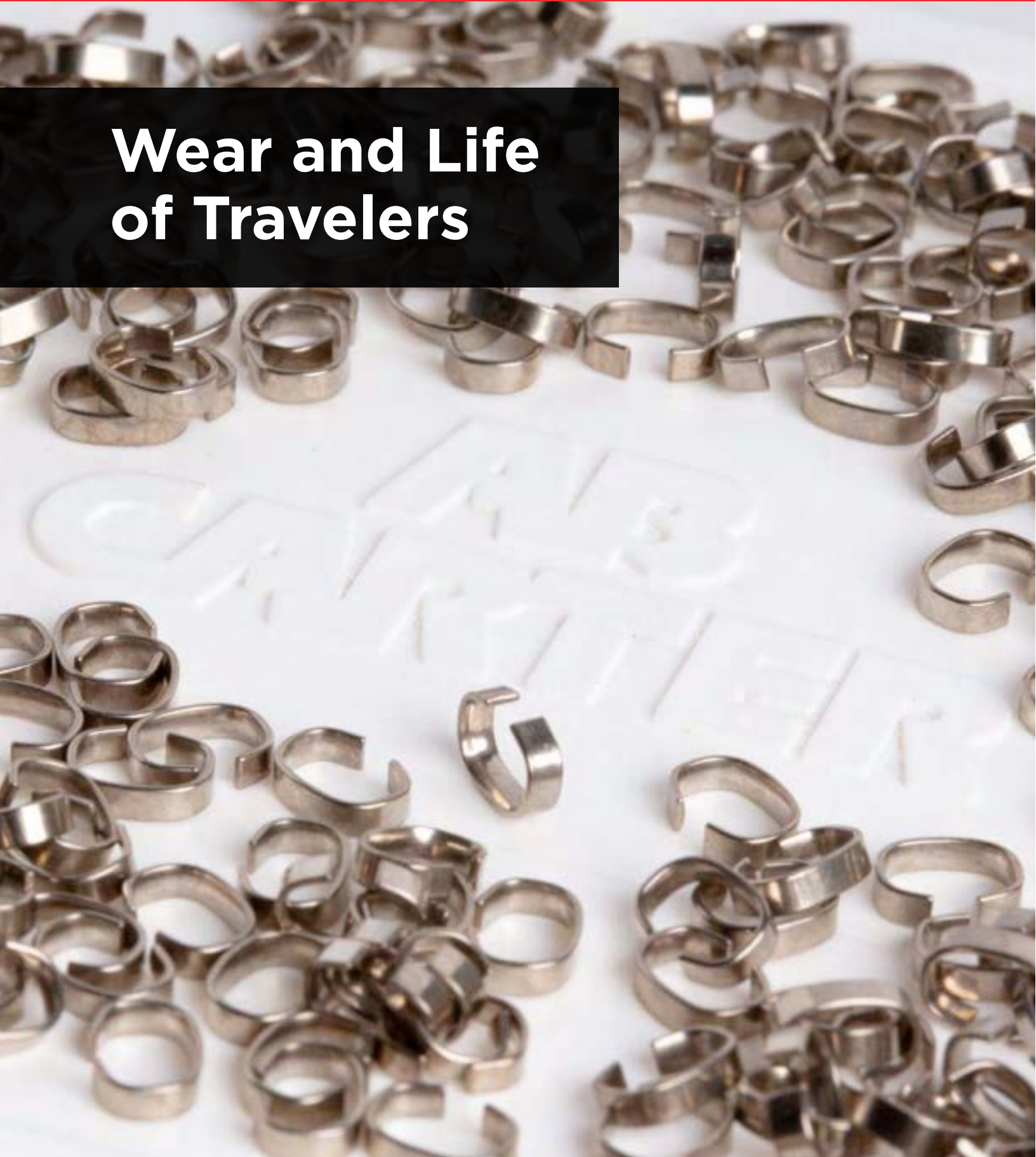

# Wear and Life of Travelers



Extending traveler life is a common goal for most mill managers. Prolonging the traveler change cycle can result in reduced cost and increased productivity if monitored properly. Care should be taken not to extend the traveler change cycle beyond the point where badly worn travelers are being used, which could result in yarn quality deterioration and possible ring damage.

**The following factors have a direct impact on the wear and life of travelers:**

- **Condition of rings**
  - Age condition of rings
  - Time of operation
  - Procedure of breaking-in
  - History of yarn changes
- **Property of yarn**
  - Fiber processed
  - Imperfection of yarn
  - Evenness
  - Twist level
- **Compact vs conventional**
- **Operating conditions**
  - Traveler speed
  - Ambient temperature

All of the above mentioned factors can vary from mill to mill, thus making a direct comparison between mills is virtually impossible.

**Classification of travelers in terms of wear:**

- a) Burnt - these are travelers with a deep blue or black coloring on the inside, with brown shading on the outside surface of the horn.
- b) Worn - these are travelers with a knife edge on one side, and an indentation which is over 2/3 of the traveler thickness on the other side.
- c) Pitted - these are travelers with inside wear on one side only, near the flange opening (tip of horn).
- d) Normal - these are travelers which have an indentation of 1/3 - 1/2 of the traveler thickness without any coloring on the outside, although on the inside they may have a trace of black.



**Normal Wear Pattern**  
Proper Working  
Conditions



**Excessive Wear Pattern**  
Traveler Should  
Be Changed



**Incorrect Wear Pattern**  
Different Style  
Required





# Ring Spinning: Problems and Solutions

There are many factors that can influence efficiency, productivity and yarn quality in the ring spinning process. Selecting the proper traveler and ring combination will substantially reduce the overall spinning cost and optimize yarn quality. Below is a listing of common problems which occur in ring spinning along with general solutions for each of these specific problems.



## Trouble Shooting Chart

### Elevated Ends Down

Probable Cause	Solution
Traveler is too light if the ends are down on a 1/3 bobbin (cop) or less, especially right after the doff cycle. You will notice the yarn wrapped in the thread guide as a sign.	Increase the traveler weight by one number increments until the problem is resolved.
Traveler is too heavy if the ends down are excessive on a 2/3 bobbin or more, increasing until the doff cycle. You will also notice increased traveler wear. Will be evident on 100% of the positions.	Decrease the traveler weight until the problem is resolved.
Incorrect traveler style or profile.	Change to correct traveler and/or profile.
Excessive traveler wear.	Reduce traveler change cycle.
Alignment problems: thread guide, balloon control, spindle or ring.	These should be observed, if there is a problem it should be corrected.
Ring has reached useful life.	Send ring for analysis, along with the age of the ring, speed and yarn being made, for evaluation and recommendation.
Spindle speed too high.	Refer to reference guide for industry standards.
Incorrect spinning geometry.	Correct the angle of yarn pull (Make sure ring diameter relates properly to spinning bobbin/tube length and diameter).
Conditions.	Adjust temperature and relative humidity to proper levels.
Traveler loading.	Set cleaners to recommend settings (Refer to reference guide).
Spinning tension exceeds yarn strength.	Increase twist level and/or reduce speed.
Rough yarn contact surfaces.	Replace any worn machine parts such as cots, thread guides, balloon control rings, etc.
Fiber problem: dirty cotton, staple length, change in finish on synthetics, uneven roving, etc.	Correct processes before spinning.
Wrong condenser.	Install proper condenser for yarn count.

**Trouble Shooting Chart (continued)****Elevated Ends Down at Start-Up**

Probable Cause	Solution
Unthreading of travelers	Adjust frame start-up program. Possibly run a bigger circle.
Travelers loading	Set cleaners to recommend settings (Refer to reference guide)
Excessive ring wear	Replace rings

**Excessive Traveler Wear**

Probable Cause	Solution
Traveler is too heavy	Decrease traveler weight, assuming proper fit
Incorrect fit	Ask a Carter representative if the traveler is the correct application
Travelers loading	Set cleaners to recommend settings (Refer to reference guide)
Excessive ring wear	Replace rings
Conditions	Adjust temperature and relative humidity to proper levels.
Static	If the static electricity is too high the traveler will wear prematurely. Increase the humidity to correct the problem.
Traveler Cleaners causing increased tension on a percentage of the positions	"Set cleaners to recommend settings. (Refer to reference guide)"
Incorrect Spinning geometry	Correct the angle of yarn pull (Make sure ring diameter relates properly to spinning bobbin/tube length and the diameter).
Ring is damaged or needs to be changed	Send ring for evaluation.



**Trouble Shooting Chart (continued)****Yarn Hariness**

Probable Cause	Solution
Traveler is too light, causing too much yarn pressure on the anti balloon ring or the separator	Increase the traveler weight
Insufficient yarn clearance with traveler	Increase traveler height
Traveler wear	Flat wire gives best appearance followed by hrw/hrwd on 100% cotton yarns. (speed and performance are the determining factors)
Alignment problem (spindle/ring, thread guide, balloon control)	Correct alignment
Static	Increase humidity
Rough ring surface	Replace rings

**Neps**

Probable Cause	Solution
Yarn clearance too tight	Select traveler with higher profile
Wrong wire profile	Select different style traveler/profile
Spinning tension too high	Select lighter traveler

**Yarn Sloughing at Winding**

Probable Cause	Solution
Soft bobbin build	Increase traveler weight

**Fiber Shedding (Synthetics)**

Probable Cause	Solution
Insufficient yarn clearance	Use higher profile traveler
Alignment of rings and thread guides	Properly align rings and guides
Traveler speed is too high for fiber type	Reduce spindle speed
Poor fiber quality	Contact fiber supplier



# FLANGE: **Spinning Rings**





### Royal Rings

Royal Rings are a NEW ERA of chrome plated rings. The superior surface finish combines a high level of coating consistency, optimum coating adhesion and minimal standard deviation among rings to offer longer life, increased traveler performance and consistent yarn quality for all raw material and spindle speeds.



### Spartan Rings

Spartan Rings are designed for medium speed applications on all fiber types and counts. These rings offer an excellent quality/price ratio and are available for any brand spinning frame.





## Description and Configuration of Rings for all Types of Spinning Frames

### 1) Reversible Ring, for Platt, Roberts Arrow, Saco-Lowell

ID = Inner Diameter / OD = Outer Diameter / H = Height



### 2) Non-Reversible Ring for Rieter and Chinese Made (Spinning Frames)

ID = Inner Diameter / OD = Outer Diameter / H = Height

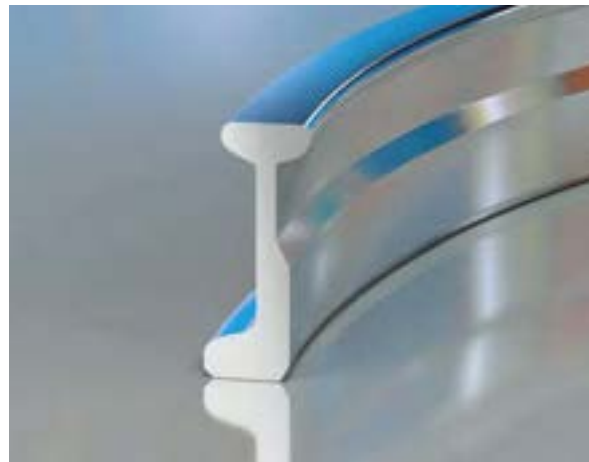
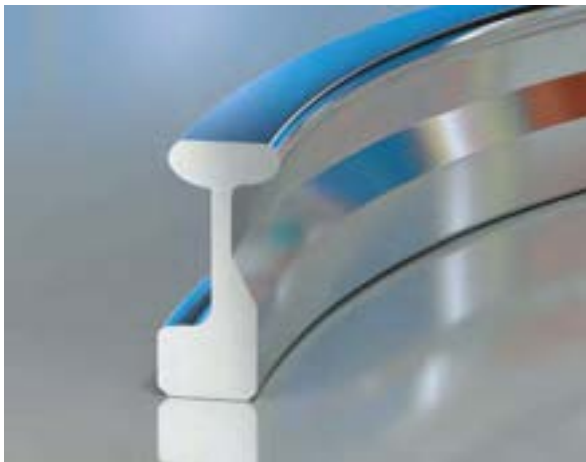





### 3) Non-Reversible Ring, for Marzoli, Textima and Old Rieter

ID = Inner Diameter / OD = Outer Diameter / H = Height



### 4) Single Flange and Royal Ring AL Rings, for Toyoda, Howa and Zinser

ID = Inner Diameter / OD = Outer Diameter / H = Height







### 5) Single Flange Suessen

ID = Inner Diameter / OD = Outer Diameter / H = Height

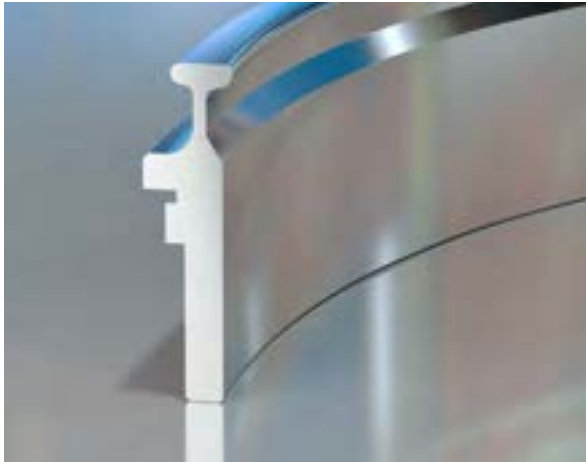

### 6) Press System Adjustable

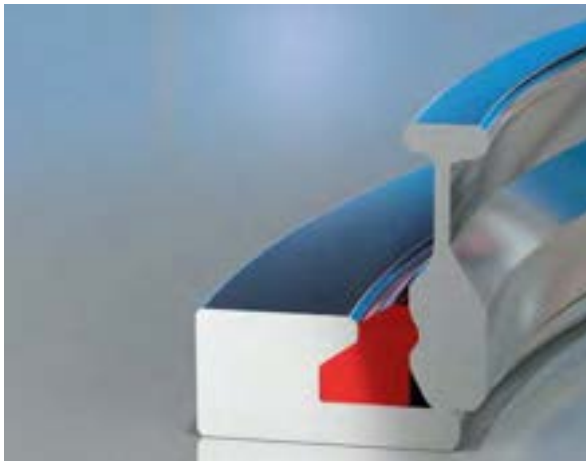

### 7) Press System on Base

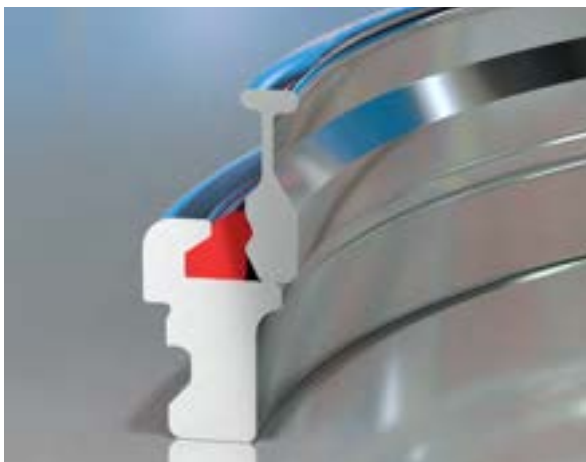



### **Break-In Instructions for Rings**

All ring manufacturers are constantly working to develop new ring finishes that will allow rapid ring break-in, but to date there are no rings made of normal steel which do not require breaking-in. Breaking - in of steel rings allows the running surface of the rings to be polished by the travelers.

Since the travelers run at different positions throughout the build of the bobbin, a thorough break - in process is required for the travelers to polish the rings for all traveler position and tension changes during the bobbin build.

A thorough break - in yields the best traveler performance consistent for each ring on the frame. It also assures the best traveler life and ring life assuming proper maintenance and traveler change schedules are maintained.

Therefore, a proper breaking-in process for new rings is an absolute necessity. An improper or insufficient breaking-in process will hamper the performance of the traveler and shorten the life span of the rings.

All of our flange rings are covered with protective oil when delivered. It is necessary to clean new rings with a dry cloth before installation to remove any protective oil on rings.

The duration of breaking-in varies according to the type of finish on the rings.

**Always use AB Carter travelers  
when breaking-in AB Carter rings!**





The following tables show the normal running-in cycle for our Royal Rings and Spartan Rings. Duration and total number of traveler replacements would be determined by the condition of wear as well as the percentage of burnt travelers after replace replacement.

### Break-In Instructions for Royal Rings

Phase	Spindle Speed	Traveler Change Duration <sup>1</sup>	Traveler Number	Notes
I	90%	1 hour	1,2 numbers lighter	Ring cleaning <sup>2</sup>
	90%	12 hours	Normal traveler	
II	95%	24 hours	Normal traveler	Traveler inspection <sup>3</sup>
	95%	48 hours	Normal traveler	
	95%	72 hours	Normal traveler	
III	100%	72 hours <sup>4</sup>	Normal traveler	
	100%	120 hours <sup>5</sup>	Normal traveler	Traveler inspection <sup>3</sup>

\*\* After the end of running-in the rings might require 1 or 2 number heavier travelers than the conventional rings now installed spinning at the same conditions.

Always use AB Carter travelers when breaking-in AB Carter rings.

**IMPORTANT NOTES:**

1. The traveler change must be done with 1/3 full (not with empty tubes!).
2. Clean rings with a dry cotton cloth to remove dust accumulation.
3. If the % of burnt traveler is more than 5%, then the last traveler change duration is to be repeated until % of burnt travelers is less than 5%.
4. From this step and after every traveler change (during normal production) the speed should be reduced to 90% of final speed for the first 30 minutes. This procedure will increase traveler life.
5. From this step, if the % of burnt traveler is less than 5%, traveler replacement cycle can be extended by 24 hours per change until normal cycle is achieved.

**NOTE:**

**This break-in schedule is subject to change depending on yarn count, fiber product and spindle speed.**



### Break-In Instructions for Spartan Rings

Phase	Spindle Speed	Traveler Change Duration <sup>1</sup>	Traveler Number	Notes
I	80% of final speed	1 hour	2 nr. heavier traveler	Ring cleaning <sup>2</sup>
	80% of final speed	1 doff	2 nr. heavier traveler	
	80% of final speed	2 doffs	2 nr. heavier traveler	Traveler inspection <sup>3</sup>
II	90% of final speed	1 doff	1 nr. heavier traveler	
	90% of final speed	2 doffs	1 nr. heavier traveler	
	90% of final speed	4 doffs	1 nr. heavier traveler	
	90% of final speed	8 doffs	1 nr. heavier traveler	Traveler inspection <sup>3</sup>
III	Final Speed	1 doff	Normal Traveler	
	Final Speed	2 doffs <sup>4</sup>	Normal Traveler	Traveler inspection <sup>3</sup>
	Final Speed	4 doffs	Normal Traveler	
	Final Speed	8 doffs	Normal Traveler	Traveler inspection <sup>3</sup>
	Final Speed	12doffs	Normal Traveler	
	Final Speed	26 doffs	Normal Traveler	Traveler inspection <sup>3</sup>
	Final Speed	24 doffs	Normal Traveler	
	Final Speed	32 doffs	Normal Traveler	Traveler inspection <sup>3</sup>
	Final Speed	40 doffs <sup>5</sup>	Normal Traveler	Traveler inspection <sup>3</sup>

Always use AB Carter travelers when breaking-in AB Carter rings.

**IMPORTANT NOTES:**

1. The traveler change must be done with 1/3 full (not with empty tubes!).
2. Clean rings with a dry cotton cloth to remove dust accumulation.
3. If the % of burnt traveler is more than 5%, then the last traveler change duration is to be repeated until % of burnt travelers is less than 5%.
4. From this step and after every traveler change (during normal production) the speed should be reduced to 90% of final speed for the first 30 minutes. This procedure will increase traveler life.
5. From this step, if the % of burnt traveler is less than 5%, traveler replacement cycle can be extended by 24 hours per change until normal cycle is achieved.



# STEEL TRAVELERS: ....for long Staple Spinning and Twisting!





### STEEL TRAVELERS

...for long Staple Spinning and Twisting!

... Both **J Type (Conical)** and **HZ (Vertical)** are offered in specific sizes and styles to assure optimum performance in all spinning and twisting applications. Our travelers are manufactured from the highest quality raw materials to assure consistent performance and excellent wear resistance. Made to fit all ring profiles along with a mirror polished surface, **CARTER TRAVELERS** give you the best combination of quality and performance.

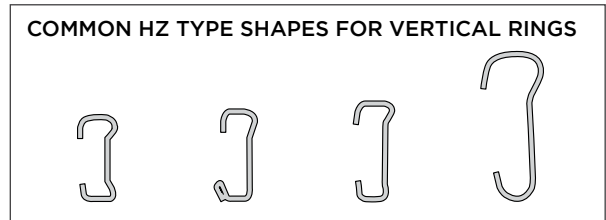
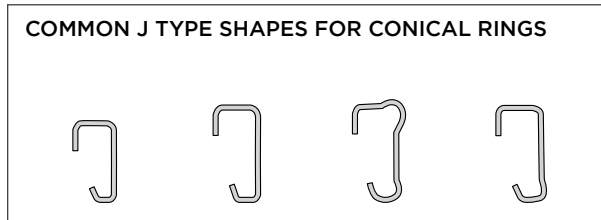

#### J Type Traveler for Conical Ring

- 1. Suitable traveler weight  
Even wear on head and back.
- 2. Traveler Too Light  
Excessive wear on foot.
- 3. Traveler Too Heavy  
Excessive wear on head.

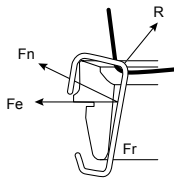

#### HZ Type Traveler for Vertical Ring

- 1. Suitable traveler weight  
Even wear on back and foot.
- 2. Traveler Too Light  
Excessive wear on head only.
- 3. Traveler Too Heavy  
Excessive wear on foot only.

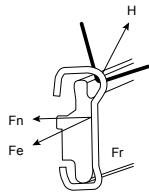

Available Finishes	Application
<b>BRILLIANT</b>	High polished surface to enhance yarn quality and runnability on all fiber types.
<b>MIRACLE</b>	Special nickel finish to enhance wear resistance and prevent corrosion.
<b>JETGS</b>	Specially designed premium finish to enhance traveler life while minimizing yarn hairiness.



**Table Comparing Weights and Numbers**

CARTER		REINERS+FUST		BRACKER		CARTER		REINERS+FUST		BRACKER	
ISO NO	R+F NO	ISO	BRAKER NO	ISO	ISO NO	R+F NO	ISO	BRAKER NO	ISO		
12	40	11.8	-	-	68	25.5	67	25	71		
13.5	39	13.2	38	14	75	25	75	-	-		
15	38	15	-	-	84	24.5	85	24.5	80		
16.5	37	16	37	16	92	24	90	24	90		
18	36	18	36	18	105	23.5	100	23.5	100		
19.5	35	20	35	20	110	23	112	23	112		
21	34	21.2	34	21	120	22.5	118	22	125		
22.5	33	22.4	32	22.4	130	22	132	-	-		
24	32	23.6	-	-	140	21.5	140	21.5	140		
26	31	26.5	31	25	150	20.5	150	-	-		
29	30	30	30	28	165	20	160	21	160		
31	29.5	31.5	29	31.5	180	20	180	20	180		
33	29	33.5	-	-	210	-	-	-	200		
36	28.5	33.5	28.5	35.5	230	19.5	224	19.5	224		
39	28	40	28	40	255	19	250	19	250		
44	27.5	45	27.5	45	300	18.5	300	18.5	280		
48	27	50	27	50	350	18	355	18	355		
54	26.5	53	26.5	56	400	17.5	400	17.5	400		
60	26	60	26	63	450	17	450	17	450		

Other Weights Available Upon Request

**Ring Heights Available**

**J TYPE (CONICAL)**

9.1mm (23/64")	11.1mm (7/16")	17.0mm (43/64")
----------------	----------------	-----------------

**HZ TYPE (VERTICAL)**

9.5mm (3/8")	10.3 (13/32")	11.1mm (7/16")	17.0mm (43/64")
--------------	---------------	----------------	-----------------

**Wire Profile and Application**

- Round "RW" - For processing fine count Wool and Synthetics
- Flat "F" - For heavy count Wool and Synthetics
- Oval - For medium and coarse wool and synthetic counts

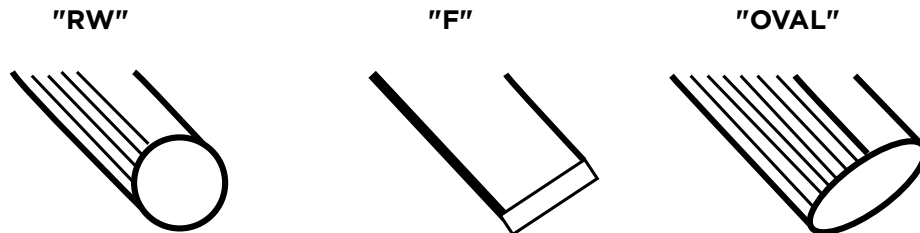



Technical  
Spinning:  
**Information and  
Formulas**

**1 One pound is 7000 grains = 453.59 grams**

One skein is 120 yards = 109.7 meters

One yard = 36 inches = 0.9144 meters

One hank is 840 yards = 768.1 meters

The yarn count and hank roving number equals the number of hanks in one pound.  
To find the hank roving number from number of grains per yard:

Divide 8.33 by the number of grains per yard.

$$\text{Hank roving number} = \frac{8.33 \times \text{yards}}{\text{grains}}$$

**2 To find the speed of the front roll**

Divide the revolutions per minute of the spindle by the product of the twist per inch, multiplied by the circumference in inches of the front roll.

$$\text{Front roll speed} = \frac{\text{Spindle R.P.M.} \times \pi \times \text{diameter of front roll}}{\text{T.P.I.}}$$

**3 To find the spindle speed**

Multiply the R.P.M. of the front roll by the twist per inch and this product by the circumference of the front roll.

$$\text{Spindle speed} = \text{R.P.M. front roll} \times \text{T.P.I.} \times \pi \times \text{diameter of front roll}$$

**4 To find the standard twist per inch**

Multiply the twist multiple by the square root of the yarn count.

$$\text{T.P.I.} = \text{T.M.} \times \sqrt{\text{yarn count}}$$

**5 To find the draft**

Yarn Count (Ne) divided by hank roving equals the draft.

**7 To find the draft gear**

The product of the back roll gear, crown gear and diameter in inches of the front roll, divided by the product of the front roll gear and diameter of the back roll equals the draft constant. Constant divided by draft gear equals draft.

$$\text{Draft Gear} = \frac{\text{Draft Constant}}{\text{Draft Gear}}$$

**8 To find the required draft gear when changing from one yarn count to another, without changing the roving**

Multiply the number of teeth in the draft gear in use by the yarn count spun. Dividing this product by the yarn count desired will give the required draft gear.

**9 To find what draft gear will be required when changing from one yarn count to another, the draft and roving both being changed**

Multiply the yarn count being spun by the new hank roving and this product by the number of teeth in the draft gear being used; divide this product by the yarn count desired, multiplied by the hank roving being used. The quotient is the draft gear required.

**10 To find the twist per inch**

Spindle speed divided by the inches of stock delivered per minute of the front roll equals twist per inch.

**11 To find inches delivered per minute**

Multiply the R.P.M.'s of the front roll by the circumference in inches of the front roll.

**12 Spinning production calculations****Delivery:**

$$L = \frac{n}{T/m} = \text{m/min}$$

**Production:**

$$\text{Ppr} = \frac{L \times \text{tex} \times 60}{1000} \times \lambda = \text{g/h}$$

or

$$\text{Ppr} = \frac{L \times \text{tex} \times 60}{T/m \times 1000} \times \lambda = \text{g/h}$$

Note:  $\pi = 3.1416$

L = Delivery in m/min  
 Ppr = Production in practice  
 n = Spindle speed in min<sup>-1</sup>  
 T/m = Twists per m  
 g/h = Gram/hour (spindle)  
 λ = Efficiency





## English Cotton Yarn Numbering System

The yarn numbering system used mostly by short staple spinners is the English cotton numbering system abbreviated as **Ne**. This system is an indirect numbering system which means the yarn number becomes smaller as the yarn weight per unit length becomes larger. Another way of showing this is:

$$\text{Indirect Yarn Number} = \text{length/weight (or mass)}$$

There are direct yarn numbering systems as well. In a direct numbering system, the yarn number becomes larger as the yarn weight per unit length becomes larger. This can be shown in this way:

$$\text{Direct Yarn Number} = \text{weight (or mass)/length}$$

The Tex system and the Denier system are examples of direct yarn number systems. The English Cotton Count system was developed in England during the industrial revolution. In order for the yarn numbers to be manageable the term “**hank**” was incorporated to be a length of 840 yards in the cotton system. (The worsted system **Nw** uses 560 yards per hank.) The yarn numbers are derived by determining how many hanks are in a pound of yarn in the **Ne** system. Therefore, if a singles yarn has 24 hanks in a pound of yarn, there will be 24 X 840 yards in one pound of yarn written as 24/1.

There are other yarn numbering systems in use by different segments of the textile industry. Some of the more common systems can be seen in the accompanying chart. It should be mentioned that the metric system is sometimes used to describe yarns produced on the short staple system. The metric system is abbreviated as **Nm**. The metric system refers to the number of meters in a gram of yarn.

-----  
An interesting note: 840 is divisible by 1, 2, 3, 4, 5, 6, 7, and 8.

### Comparison of English and Metric Measurement Systems

Weight					
ENGLISH			METRIC		
Pound	Ounce (Oz.)	Grain	Kilogram	Gram	Milligram
1	16	7000	0.435924	453.5924	453,592
2.20462	35.274	15,432.36	1	1000	1,000,000

Length					
ENGLISH			METRIC		
Yard	Foot	Inch	Meter	Cm.	Mm.
1	3	36	0.9144	91.44	9144
1.0936	3.2808	39.3696	1	100	1000



### Yarn Count Comparison Chart

Indirect Systems		Direct Systems	
Ne	Nm	Tex	Denier
6,0	10,0	100,0	900
7,0	12,0	84,0	750
8,3	14,0	72,0	643
9,5	16,0	64,0	563
10,0	17,0	60,0	529
10,6	18,0	56,0	500
12,0	20,0	50,0	450
13,0	22,0	46,0	409
14,0	24,0	42,0	375
16,5	28,0	36,0	321
18,0	30,0	34,0	300
19,0	32,0	32,0	281
20,0	34,0	30,0	265
24,0	40,0	25,0	225
26,0	44,0	23,0	205
28,0	48,0	21,0	188
30,0	50,0	20,0	180
36,0	60,0	17,0	150
40,0	70,0	14,0	129
48,0	80,0	12,5	113
50,0	85,0	12,0	108
60,0	100,0	10,0	90
70,0	120,0	8,3	75
80,0	135,0	7,4	67
90,0	150,0	6,6	60
100,0	170,0	5,8	52
105,0	180,0	5,5	50
120,0	200,0	5,0	45
150,0	250,0	4,0	36
180,0	300,0	3,3	30

**Standardized Fiber Abbreviations**

KP	100% Carded Cotton
CP	100% combed Cotton
AC	Acetate
AF	Other Fibers
BB	Bamboo
CLY	Lyocell (Tencel)
CMD	Modal
CO	Cotton
CTA	Triacetate
CU	Cupro
CV	Viscose
EL	Elastane, Spandex, Lycra
FG	Fiberglass
HA	Hemp
JU	Jute
LI	Flax/Linen
MAC	Modacrylic
ME	Metal
PA	Polyamide, Nylon
PAN	Acrylic
PES	Polyester
RA	Ramie
SE	Silk
SI	Sisal
WA	Angora
WB	Beaver
WG	Vicuna
WK	Camel Hair
WL	Llama
WM	Mohair
WO	Wool
WP	Alpaca
WS	Cashmere
WV	Virgin Wool
WY	Yak



# Accessories & Other Parts





### Traveler Hooks

Designed to assist in traveler installation and removal. Available in different styles and configurations to accommodate varying requirements. Available with standard and stainless steel blades.

Standard Traveler Hooks



### Ergonomic Traveler Hooks

(Left hand version available upon request)



Heavy Duty Traveler Hook







## Fluff Removers

Designed to clean fiber lint from textile machinery. These devices allow safe cleaning of rolls and other machine areas where moving parts make it unsafe to clean.

### Pneumatic

Available Models:

Model 500 - (Front Exhaust)

Model 501 - (Rear Exhaust)

Blade Lengths:

7", 8", 9", 10", 12", 13", 14", 15", 16", 18",  
20", 24", 25" & 36"



### Hand-Operated

Available Models:

150mm, 200mm, 300mm,  
400mm, 500mm, 600mm,  
700mm, 800mm, 1000mm





## Carter Speed Tool

The Carter Speed Tool is an installation tool for steel travelers that uses “cartridge” or magazined travelers to enable quick replacement of the traveler onto the ring. The increase efficiency reduces labor cost and minimizes production loss during the traveler change process. The Carter Speed Tool is easy to setup and uses a rail/arbore loading system that is specifically designed for smooth and consistent operation.

### Carter Speed Tool

- Faster replacement of ring travelers
- Simple setup and use
- Lower labor cost
- Reduced down time for spinning frames





# AGENT LOCATIONS





*Trusted for the Long Run*



Use this code to  
visit our website

## **CONTACT US**

4801 York Highway, Gastonia, NC 28052 USA  
[www.abcarter.com](http://www.abcarter.com)  
[sales@abcarter.com](mailto:sales@abcarter.com)  
+1 704-865-1201